

DC 95 AGM

AGM Deep Cycle Battery | 12 V | 95 Ah | 100 h



Electrical Specifications

Nominal Voltage	12 V
Capacity C100	95 Ah (10,5 V, 25 °C)
Capacity C20	80 Ah (10,5 V, 25 °C)
Capacity C10	75 Ah (10,5 V, 25 °C)
Capacity C5	63 Ah (10,5 V, 25 °C)
Capacity C3	55 Ah (10,5 V, 25 °C)
Reserve Capacity	25 A (10,5 V ≥ 140 min)
CCA (-18 °C)	800 A (EN)
Self Discharge	< 8 % after 90 Days (25 °C)
Charge Current	0 to 24 A
Charge Voltage	14,5 to 15,0 V (25 °C)
Cycle Count	1450 (30 % DoD)
	700 (50 % DoD)
	400 (80 % DoD)
	300 (100 % DoD)

Mechanical Specifications

Dimensions (LxBxH)	315 × 175 × 190 mm
Weight	23,1 kg
Terminal	T1
Temperature Range	-30 °C to 70 °C
Case Material	High temperature resistant materials

Certificates

- EN 50342
- VDA
- GB/T5008.1-2013
- JB/T12666

Functions & Features

- Start-stop function
- Maintenance-free
- AGM separator with extremely low resistance
- Can be started at low temperatures
- Long service life, even at high temperatures

Dimensions

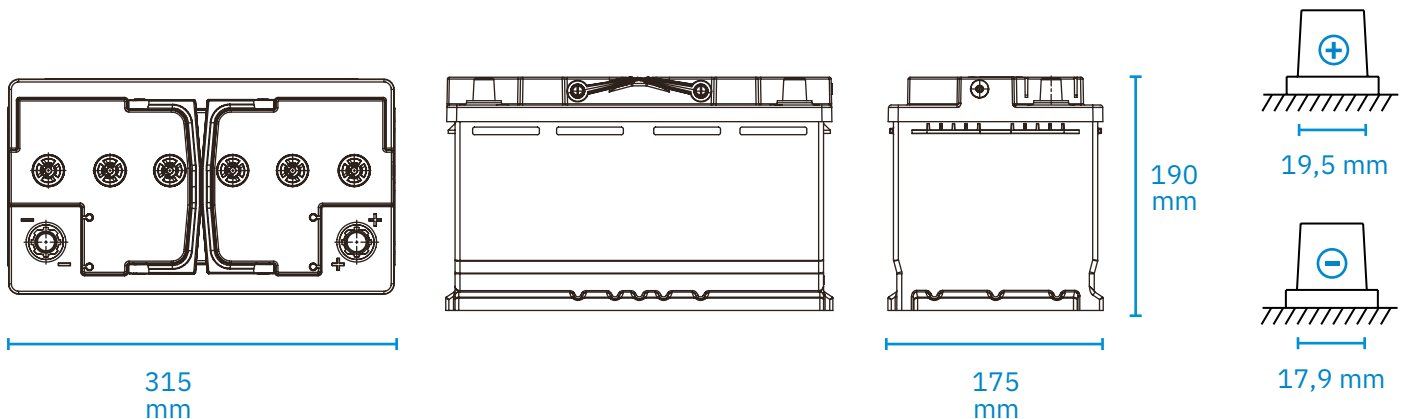

Idling Life Curve (25 °C)

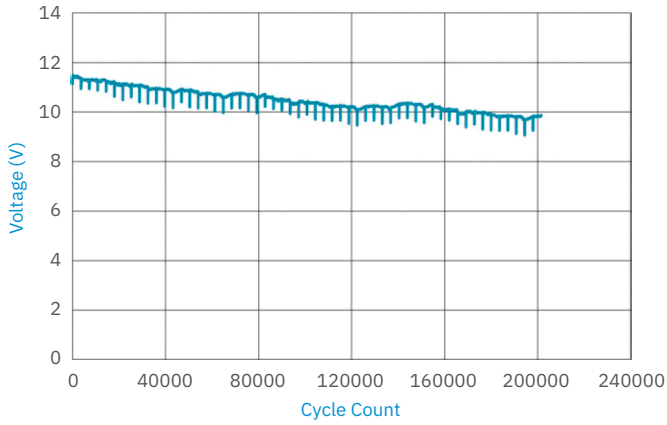

Cycle Life at 25 °C (17,5 % DoD)

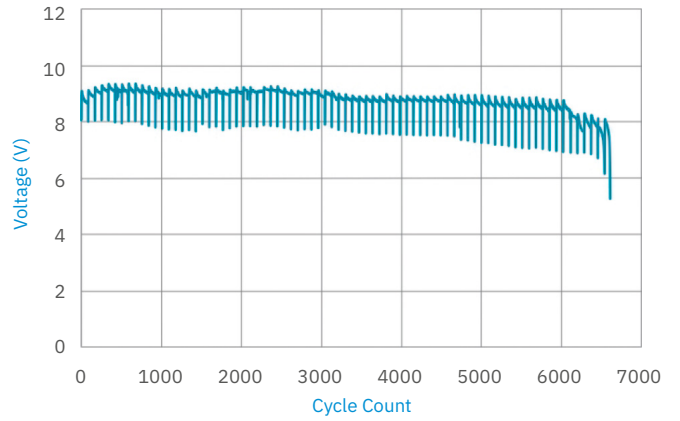

Self-Discharge at Different Temperatures

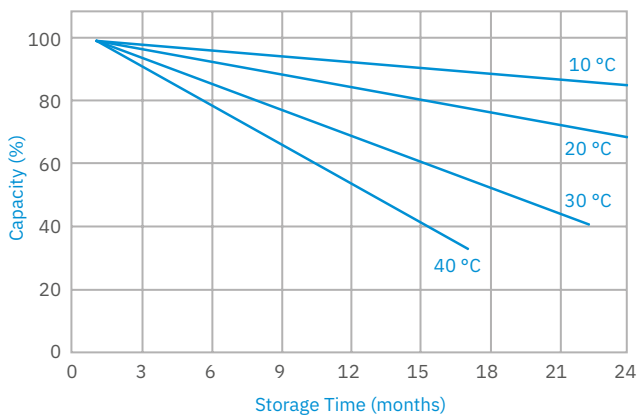

Quick Charge Performance

