



SBB 25

Battery Booster

25 A | 45 - 280 Ah | 12 to 24 V

Electrical Specifications

Charging mode	MPPT
max. Solar Module Capacity	820Wp
max. Solar Module Current	24A
max. Solar Module Voltage	50V
Battery Nominal Voltage (DC)	24V
Battery nominal capacity	45 - 280Ah
Starter battery nominal capacity min.	60Ah
“Board I” max. charge current solar	30A
“Board I” max. charge current	25A
Input voltage range “Start II”	10,5 - 16V
Input overvoltage disconnection “Start II” , max.	16,5V
Activation control input “D+”	8 - 16V
Main battery overvoltage protection	15,5V
Stand-by current	24mA

Mechanical Specifications

Measurements (L x W x H)	240 x 190 x 70 mm
Weight	1.7kg
Temperature range	-20 to 50°C
Ambient conditions	max. 95% humidity, no condensation
Optional accessories	Charge monitor, Bluetooth adapter, App display
Input “T T” for battery temperature sensor “Board I”	Yes
“Ss-” “Ss+” inputs for sensor cables “-” and “+” for Battery “Board I”:	Yes

Measurements

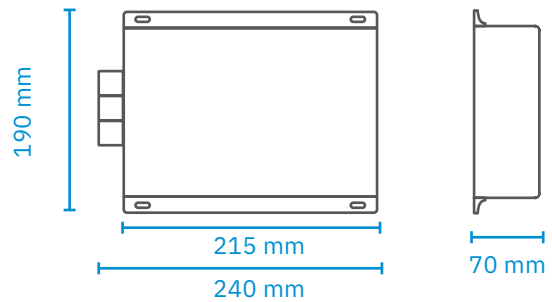

Charging Characteristics

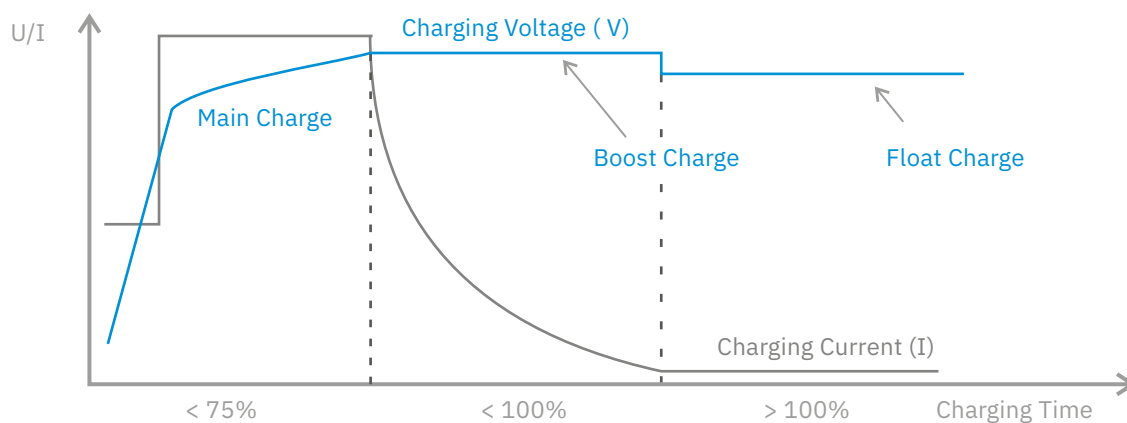

Adjustable for battery types:

- Lead acid
- AGM
- Gel
- LiFePO₄